



# 中山市川狼五金制品厂

ZHONG SHAN CHUAN LANG LIGHTING CO., LTD

型号：铂狼二代150W-180W

外观图



线条图

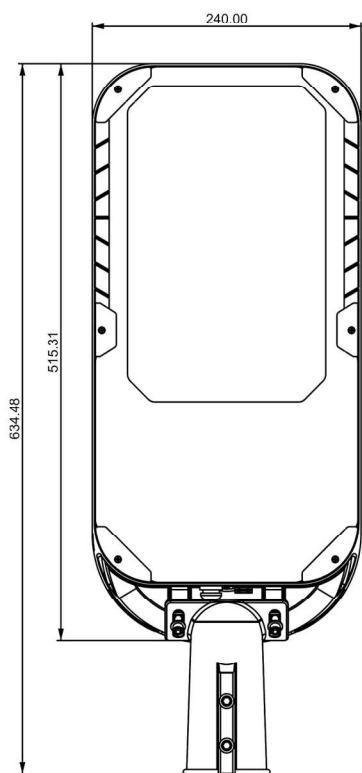

主视图

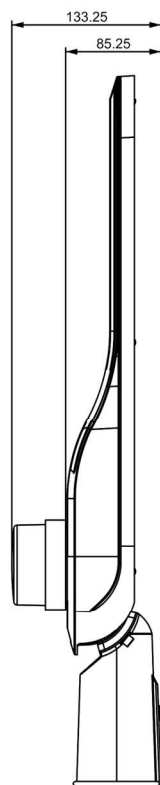

左视图

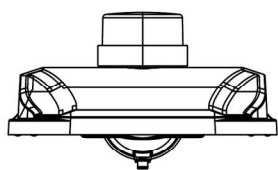

俯视图

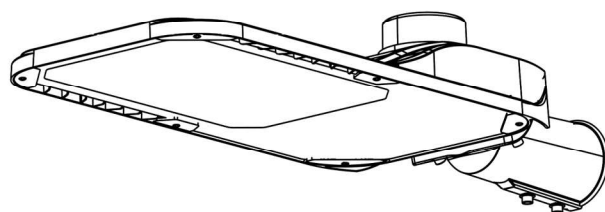

透视图

外形尺寸：240mm\*635mm\*85mm

铝基板-透镜

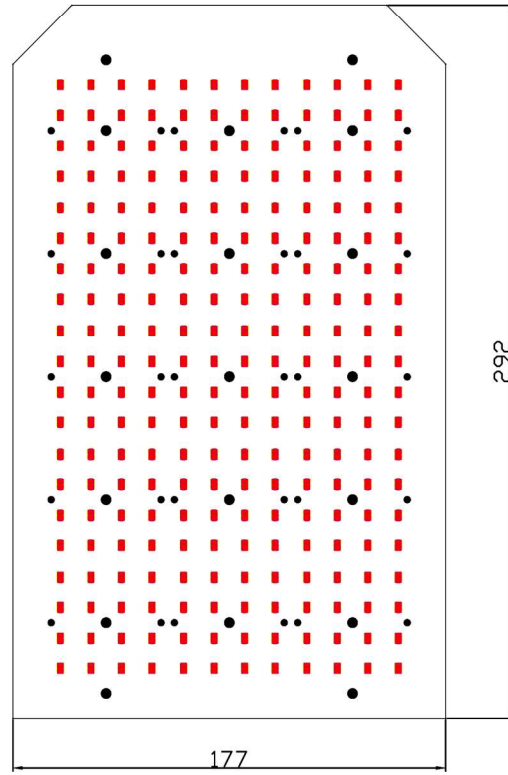

铝基板:177\*292\*T1.2 3030-8c30b

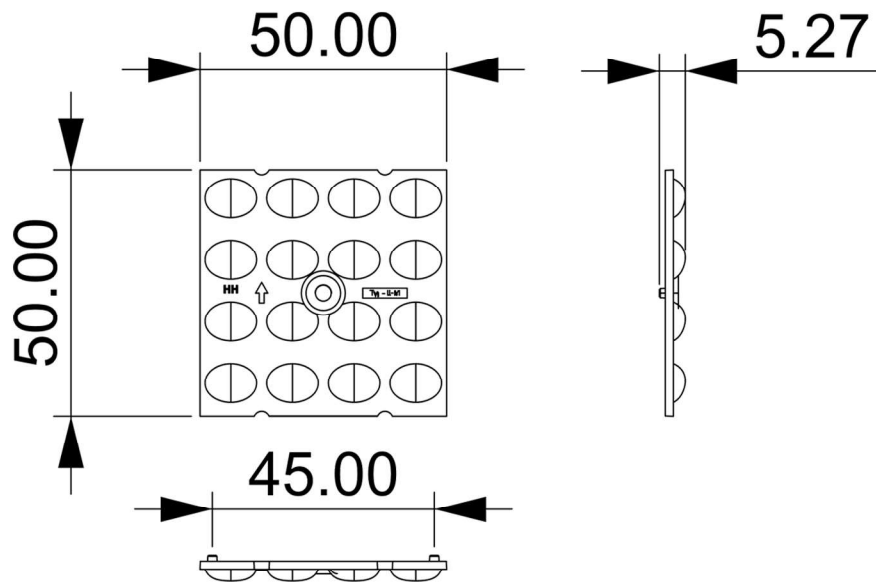

透镜:50mm\*50mm\*H5.27

透镜角度: 70\*140度

# 尺寸孔位

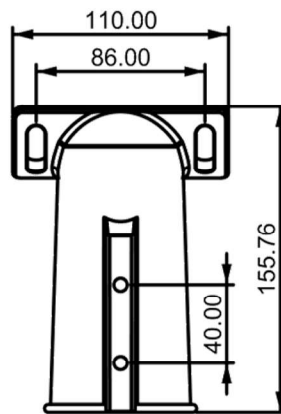
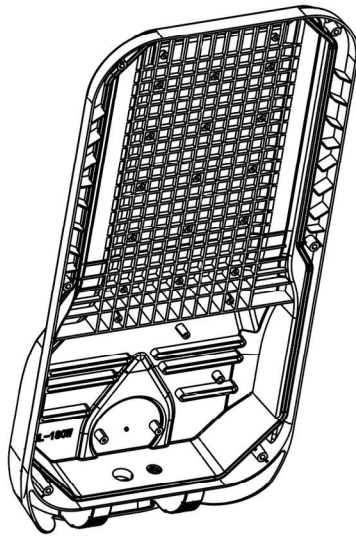
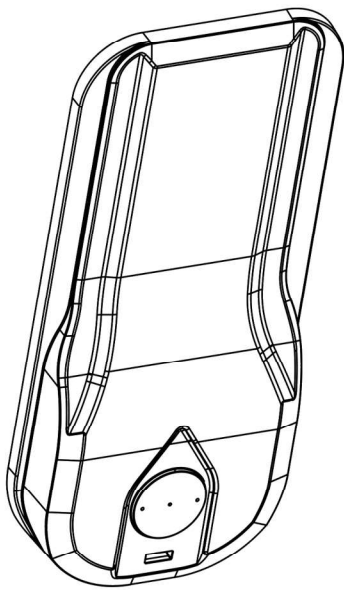
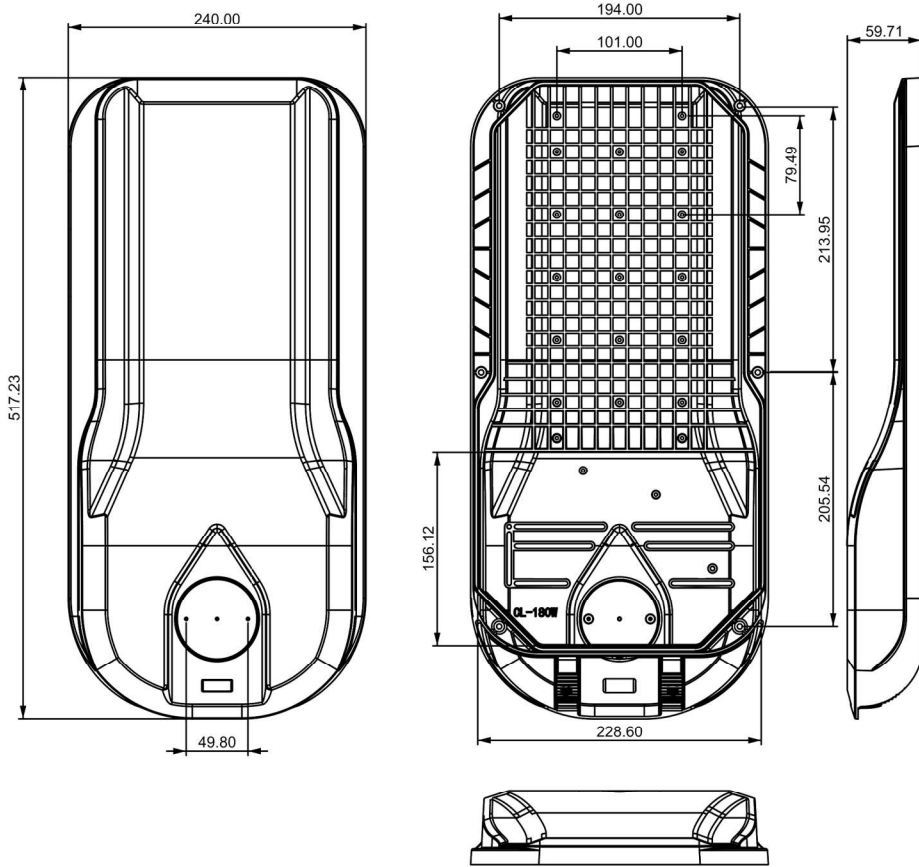

灯体尺寸：240mm\*510mm\*60mm

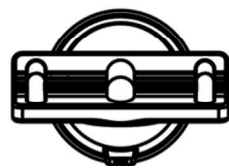

手柄尺寸：110mm\*78mm\*155mm

# 爆炸图

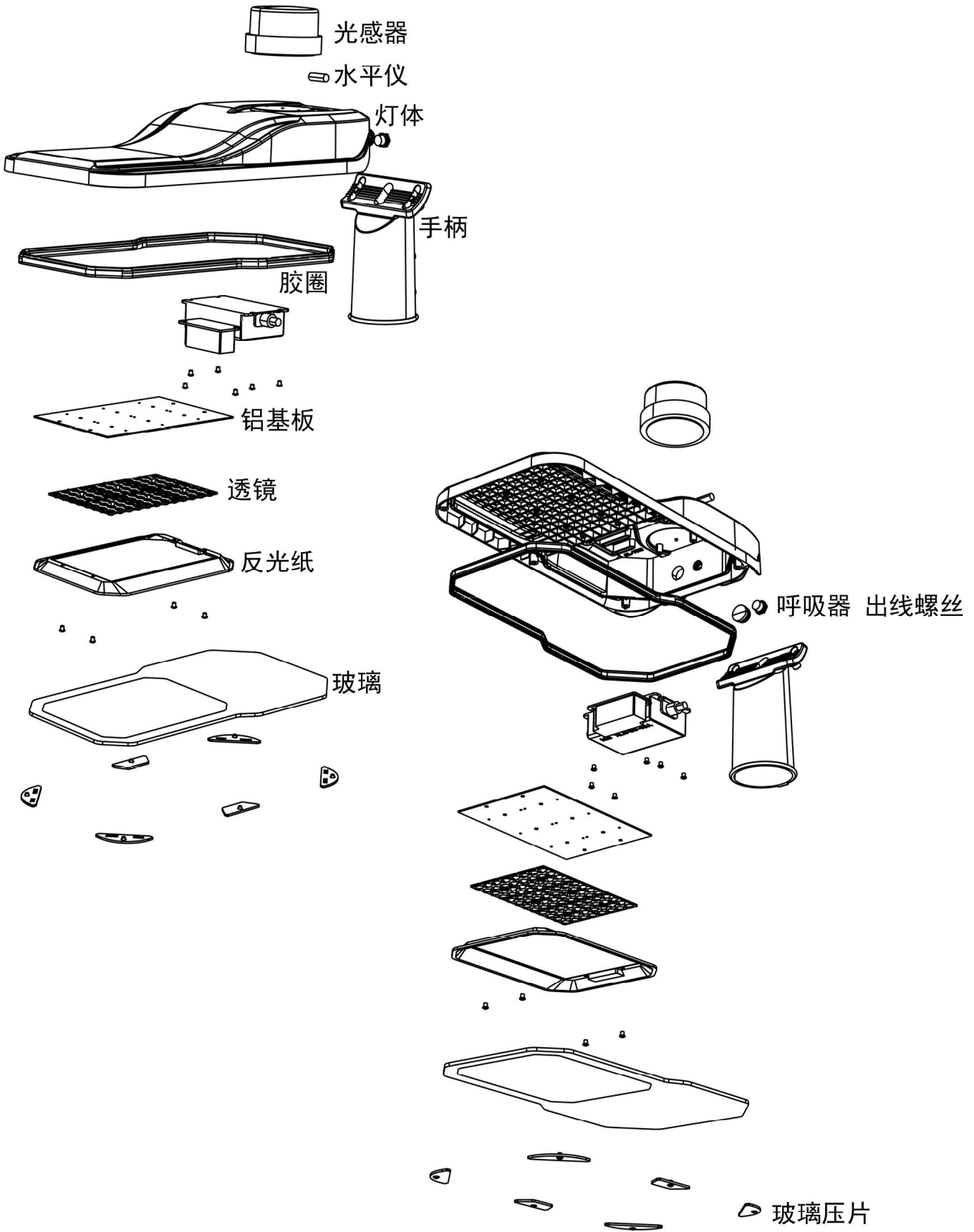

包装尺寸:

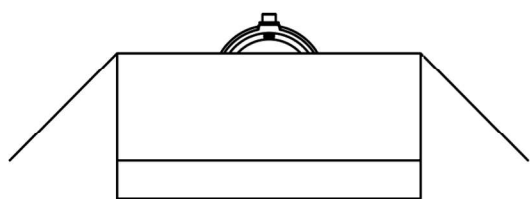
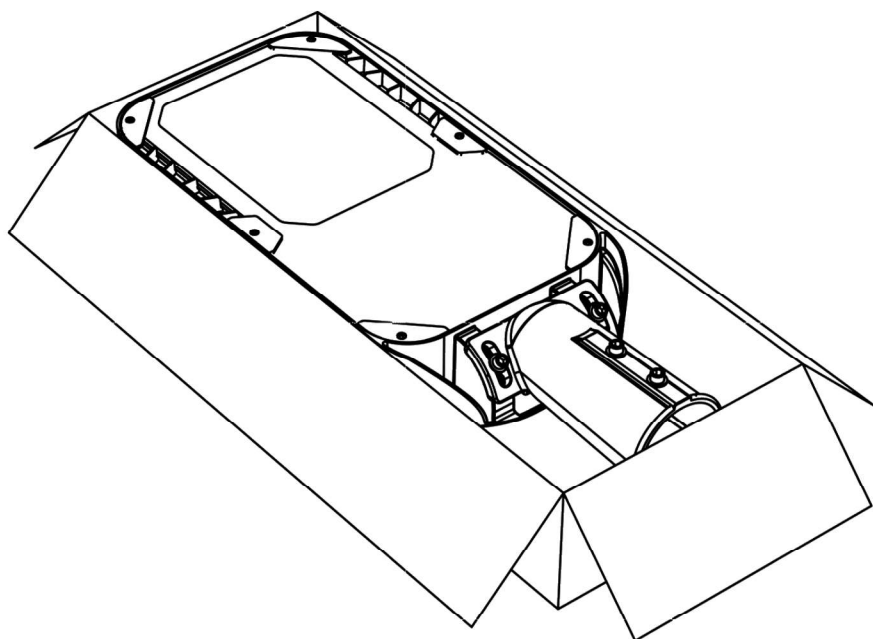
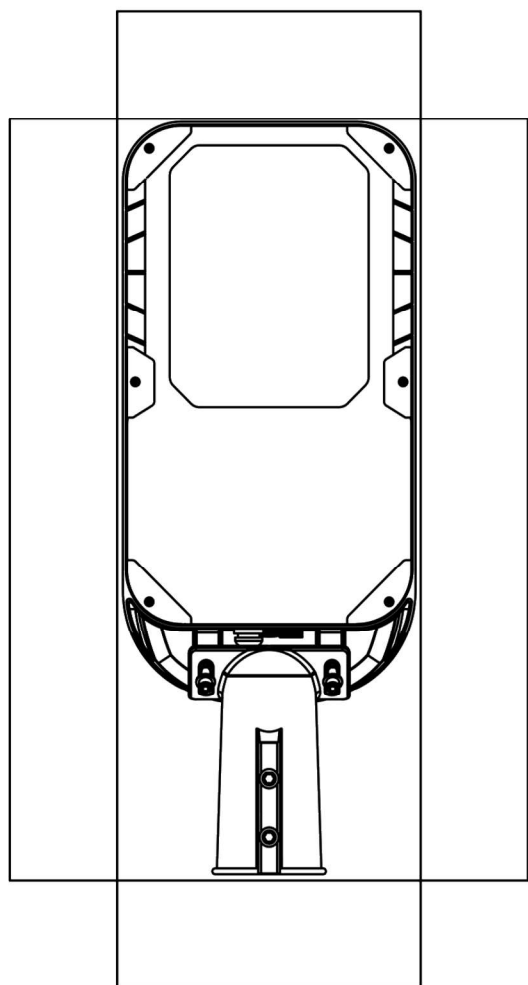

外箱尺寸: 250mm\*645mm\*100mm